

51416.

Hjeler for Drivhjul efter optakene Linier  
do "Tandhjul" "stiplede"

1	Drivhjulset komplet	Kbbes.
---	---------------------	--------

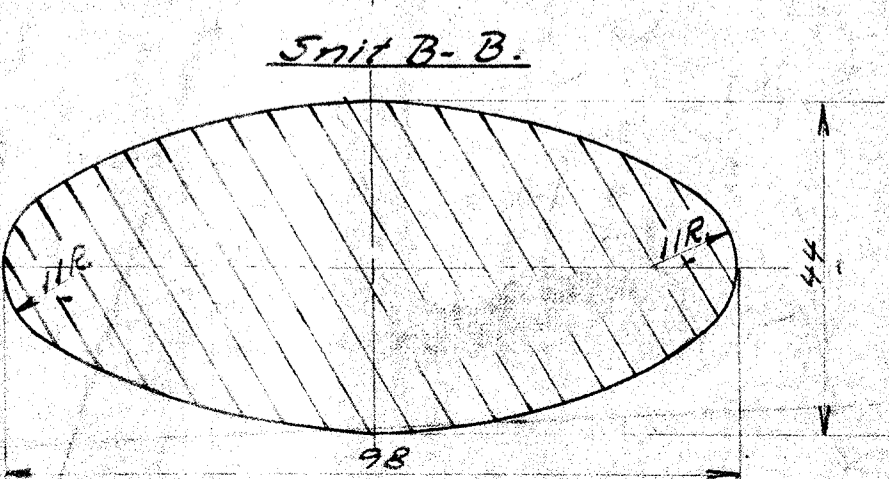
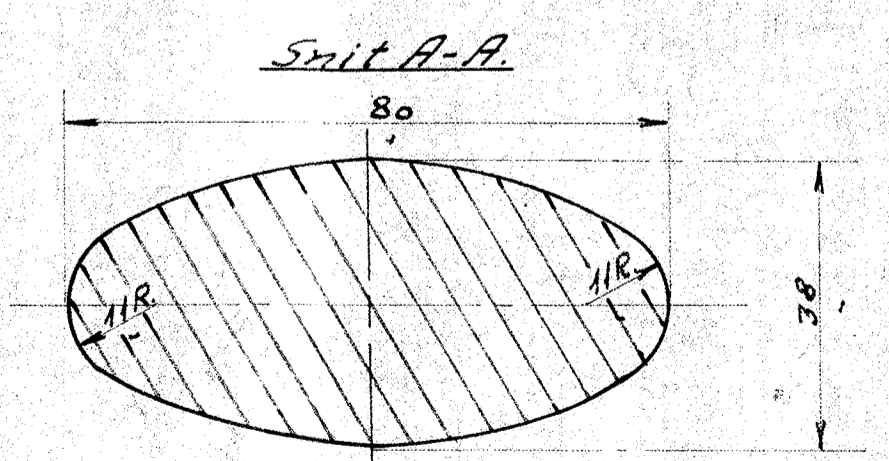
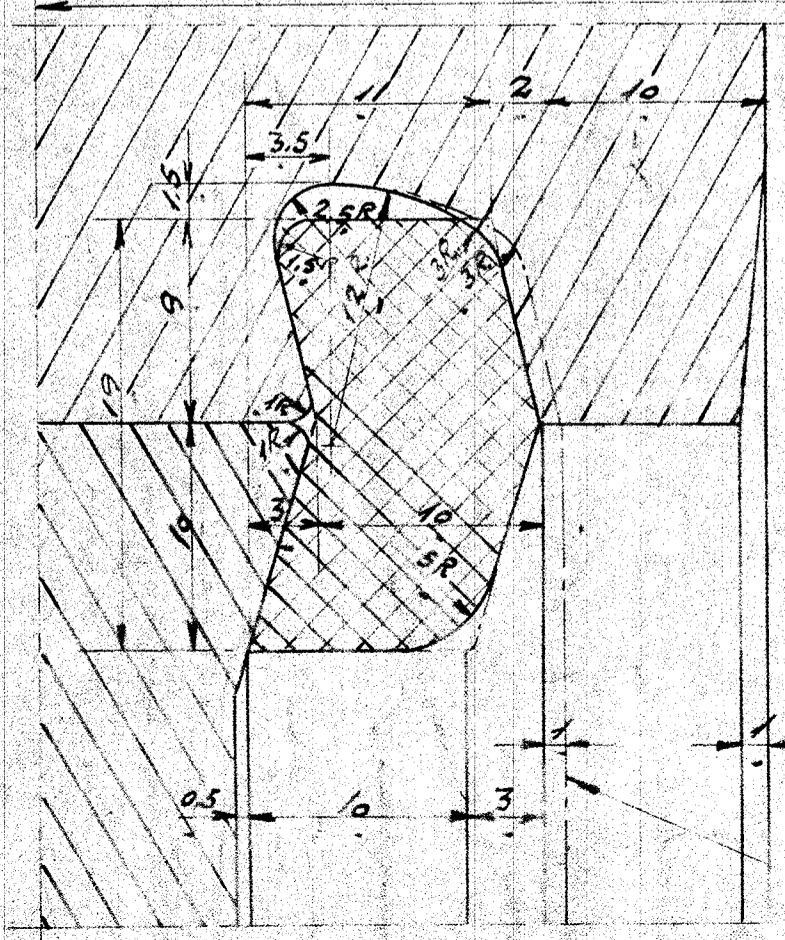
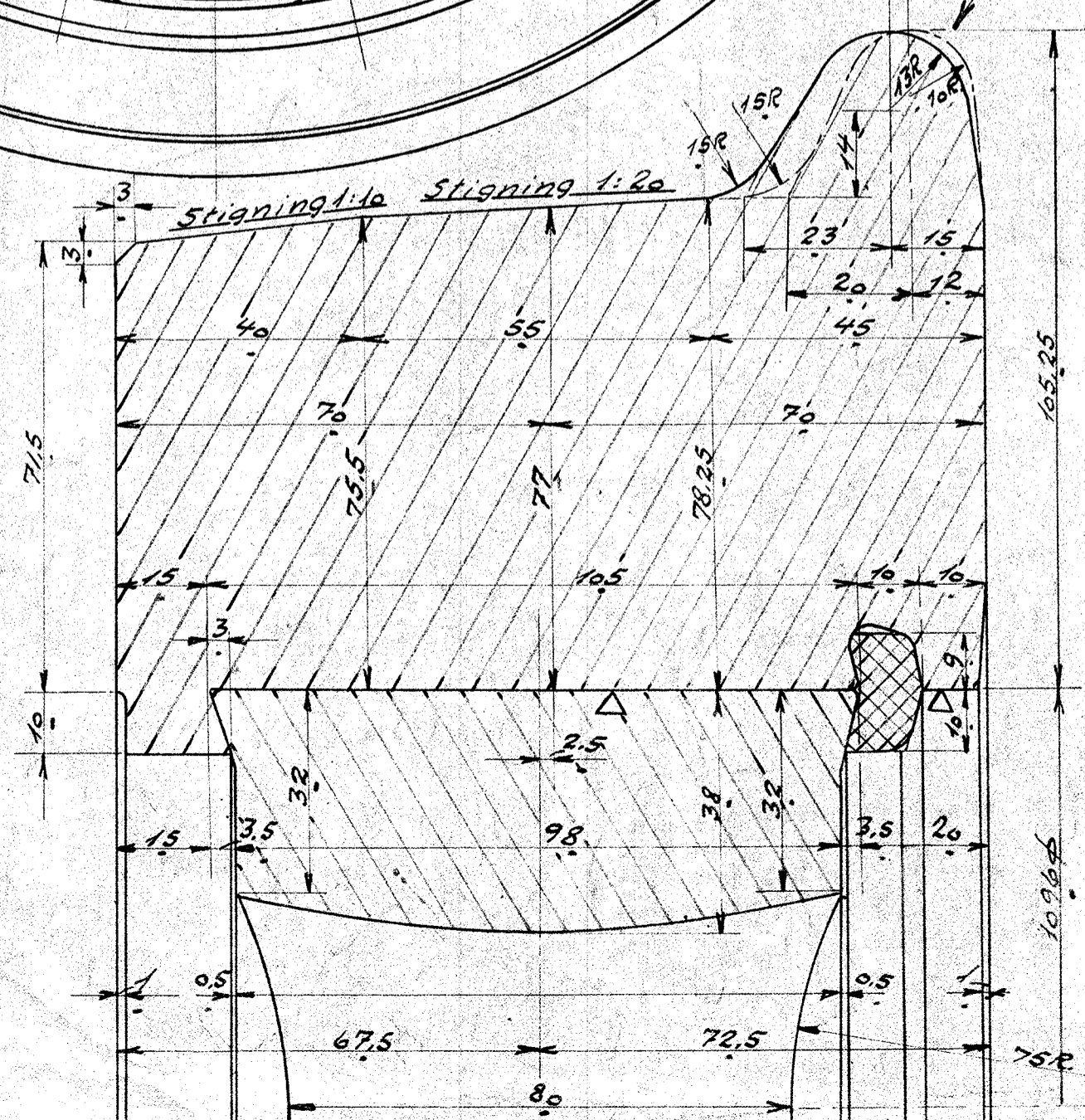
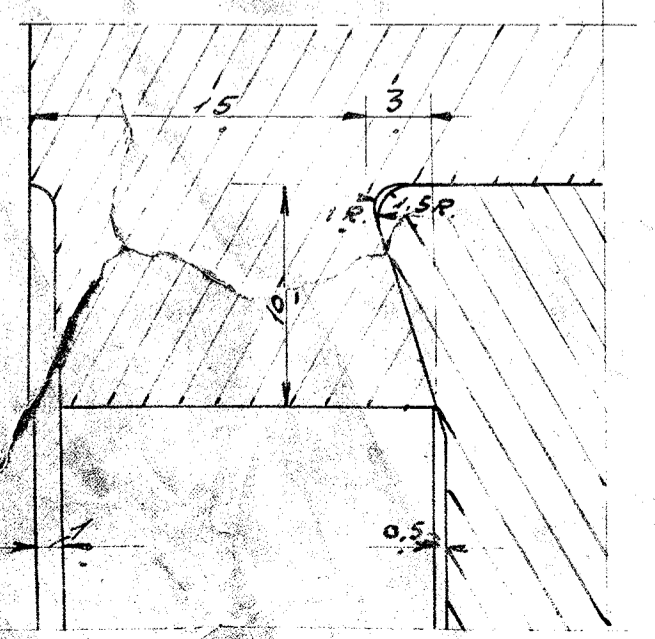
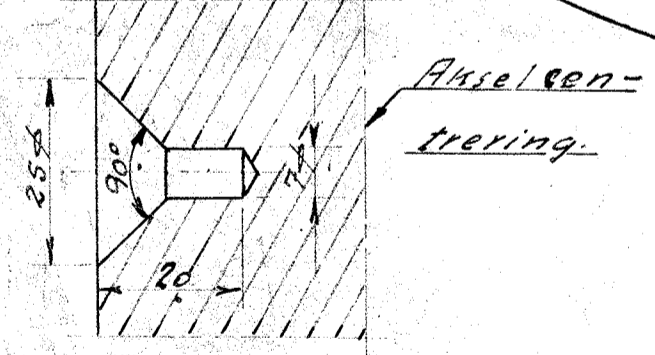
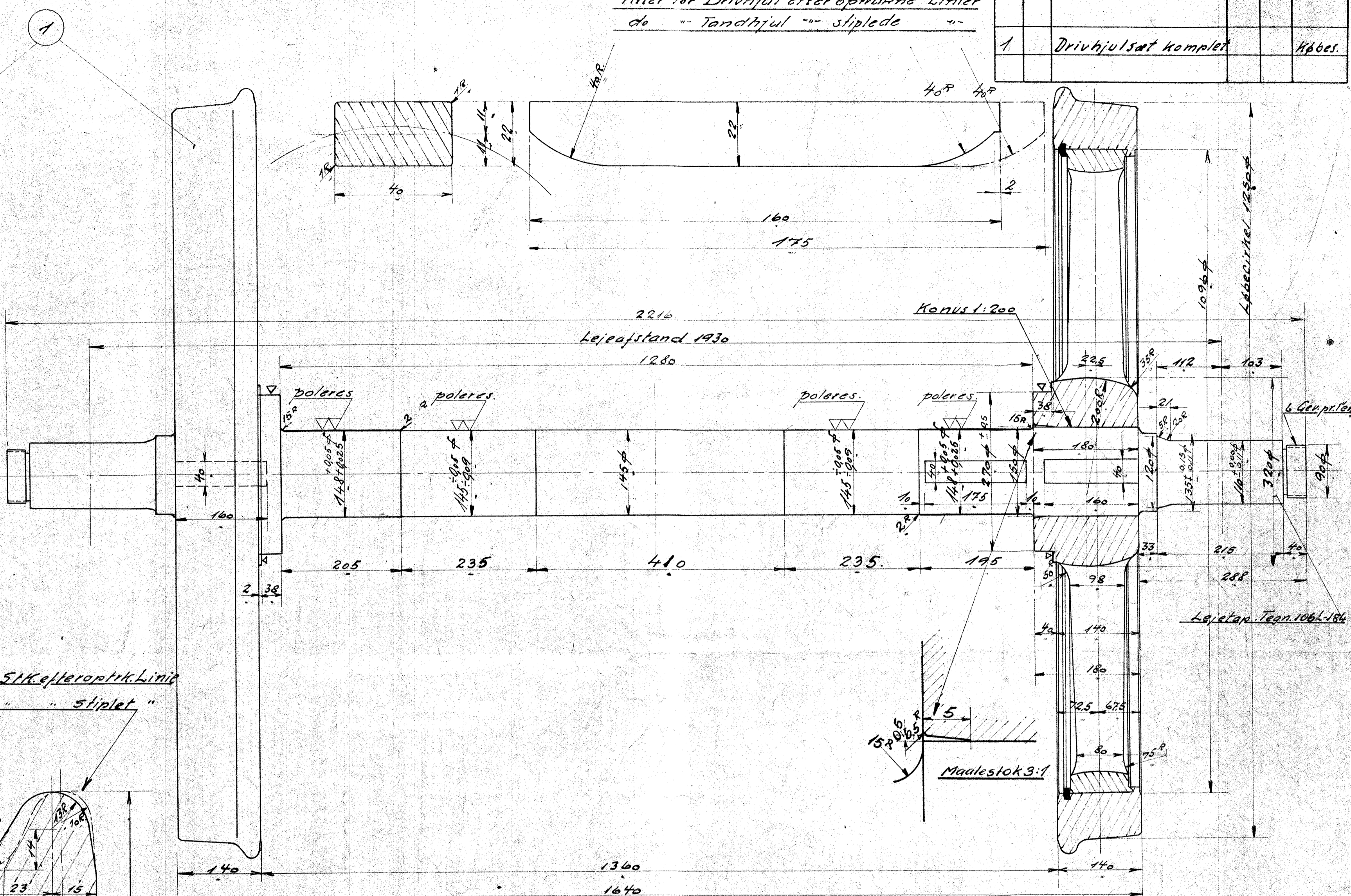
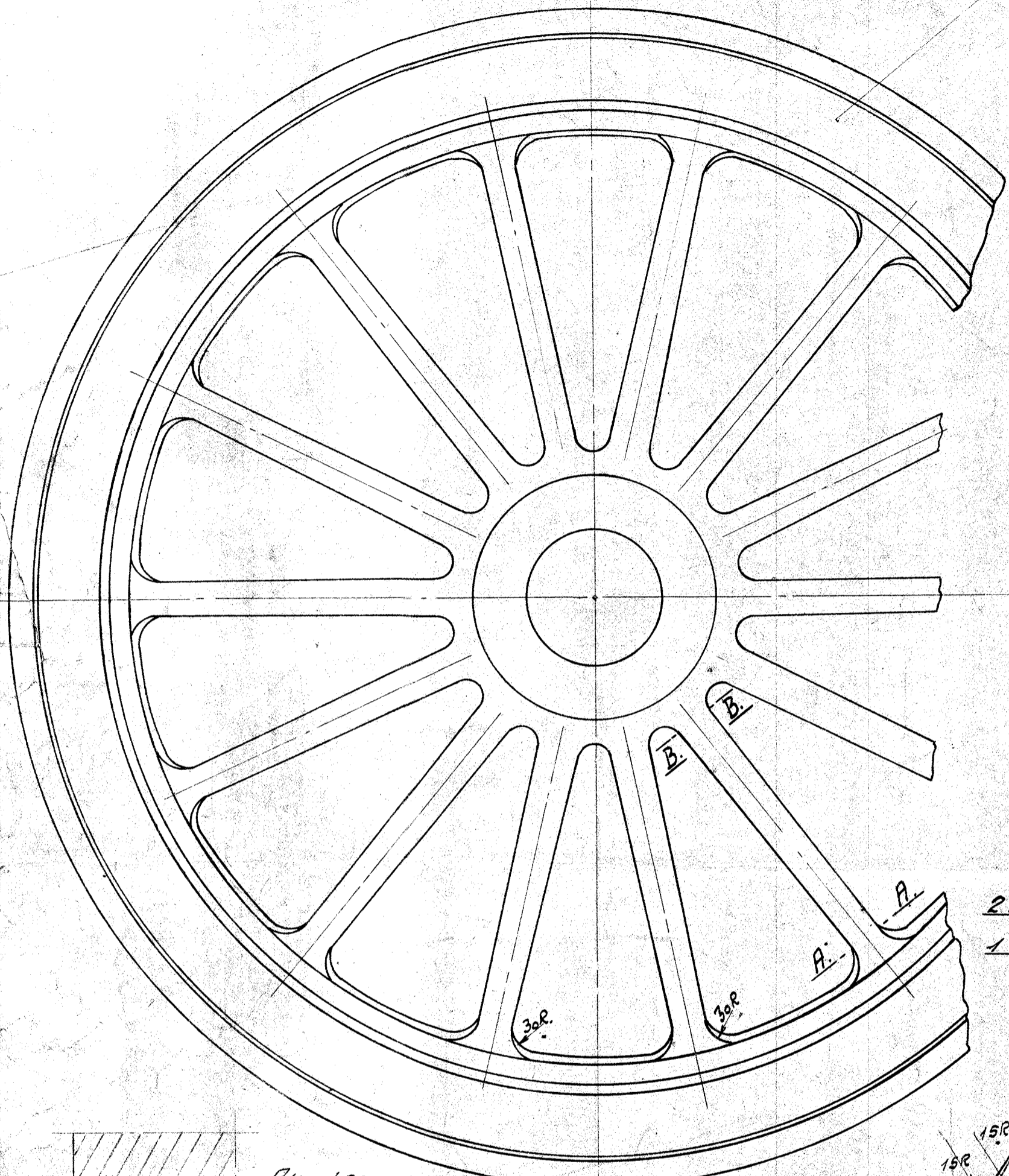

Tekniske Betingelser

Betegnelse	Materiale	Brudstyrke	Forlængelse
Hjulbandage	S.M. Staal	75 kg/mm <sup>2</sup>	12%
Hjulstjerne	S.M. Staalstøbeg	38-45 kg/mm <sup>2</sup>	25%
Akslerne	S.M. Flussstaal	54-60 kg/mm <sup>2</sup>	22%

Drivhjulset  
Diesel- el. 300HK Motorloko

E.N.		
R.T.	1:1	
Skala	1:5	
9/11931	3:1	115L-12.03